

# TECHNICAL INFORMATION MANUAL

Revision 5 – 25 July 2017

## RT0005

UHF Semi-Passive Logger Tag



**RFID4u**  
Store

Authorized Reseller:  
RFID4UStore  
[www.rfid4ustore.com](http://www.rfid4ustore.com)  
1-408-739-3500  
[sales@rfid4ustore.com](mailto:sales@rfid4ustore.com)

easy  
2  
log

**CAENRFID**

Visit [RT0005 web page](#), you will find the latest revision of data sheets, manuals, certifications, technical drawings, software and firmware. All you need to start using your tag in a few clicks!

## Scope of Manual

This manual covers technical information for the following revisions of RT0005 UHF Semi-Passive Logger Tag:

Assembly Revision <sup>(*)</sup>	Chip Revision <sup>(*)</sup>
2.5	2.0

(\*)See § Address space (page 16).

## Change Document Record

Date	Revision	Changes	Pages
04 May 10	1.0	Initial release	-
06 July 10	1.1	Added Air Link Protocol Characteristic paragraph	29
		Added information about CAEN easy2read <sup>®</sup> demo kit	8
26 Jul 10	1.2	Updated BIN_THRESHOLD registers (RW – 16 words) and BIN_SAMPLETIME registers (RW – 16 words) registers including unit of measure	22
		Updated SHL_REF_TIME register (RW) register description	23
		Added SHL_THRESHOLD register (RW) register description	23
		Changed BE and SD bit description in the Manual interface behaviour	9
		Changed chip revision	2
09 Sep 10	1.3	Changed Manual interface behaviour: extended logging enable/disable acceptance and confirmation times and changed led colour sequence	9
		Changed chip revision	2
12 Mar 13	02	Added warning	28
		Changed § Product Description paragraph	6
		Added information on RT0005ET	6
		Added information on RFID Reader Development Kits	7
		Modified § Ordering Options table	7
		Added information on Standard Gen2 memory map	16
		Modified § Temperature Accuracy Measurement paragraph	31
		Changed Battery Type, Weight and Dimensions in the Tab. 4.1: easy2log <sup>®</sup> RT0005 technical specification	28
		Modified § Mechanical Specification drawings	30
		Modified t <sub>r</sub> description parameter in the § Remaining Shelf Life calculation paragraph	14
		Replaced MKT_TEMP register with MKT_VAL register in the § Mean Kinetic Temperature calculation paragraph	14
		Changed default values in the BIN_THRESHOLD registers (RW – 16 words) Table and updated BIN_THRESHOLD register description.	22
Changed chip revision	2		
11 Jul 14	03	Modified § Manual interface behaviour paragraph	9
		Changed chip revision	2
		Modified § Ordering Options table	7
24 Nov 16	04	Changed Assembly and Chip revision	2
		Modified REGULATORY COMPLIANCE chapter	32
		Modified BIN_THRESHOLD registers (RW – 16 words) description	22
25 Jul 17	05	Modified § Ordering Options table	7
		Modified REGULATORY COMPLIANCE chapter	32
		Changed chip revision	2

# Reference Document

- [RD1] TesLab s.r.l. - Environmental Test Report - RT0005 UHF Semi-Passive Logger Tag ref. TesLab 09B207A – 10 December 2009
- [RD2] EPCglobal: EPC Radio-Frequency Identity Protocols Class-1 Generation-2 UHF RFID Protocol for Communications at 860 MHz – 960 MHz, Version 1.1.0 (December 17, 2005).

---

## CAEN RFID srl

Via Vetraia, 11 55049 Viareggio (LU) - ITALY  
Tel. +39.0584.388.398 Fax +39.0584.388.959  
[info@caenrfid.com](mailto:info@caenrfid.com)  
[www.caenrfid.com](http://www.caenrfid.com)

---

© CAEN RFID srl – 2017

## Disclaimer

No part of this manual may be reproduced in any form or by any means, electronic, mechanical, recording, or otherwise, without the prior written permission of CAEN RFID.

The information contained herein has been carefully checked and is believed to be accurate; however, no responsibility is assumed for inaccuracies. CAEN RFID reserves the right to modify its products specifications without giving any notice; for up to date information please visit [www.caenrfid.com](http://www.caenrfid.com).

---

## Disposal of the product

Do not dispose the product in municipal or household waste. Please check your local regulations for disposal/recycle of electronic products.



# Index

	Scope of Manual.....	2
	Change Document Record.....	2
	Reference Document.....	3
<b>Index 4</b>		
	<b>List of Figures.....</b>	<b>5</b>
	<b>List of Tables.....</b>	<b>5</b>
<b>1</b>	<b>INTRODUCTION.....</b>	<b>6</b>
	Product Description.....	6
	Ordering Options.....	7
<b>2</b>	<b>FUNCTIONAL DESCRIPTION.....</b>	<b>8</b>
	Main Features.....	8
	Operating states.....	8
	Manual interface behaviour.....	9
	Histogram functionality description.....	10
	Mean Kinetic Temperature calculation.....	14
	Remaining Shelf Life calculation.....	14
	Battery measurement and behaviour.....	15
<b>3</b>	<b>MEMORY DESCRIPTION.....</b>	<b>16</b>
	Address space.....	16
	User Memory map.....	18
	Register description.....	19
	CONTROL register (RW).....	19
	SAMPLING_DELAY register (RW).....	19
	INIT_DATE register (RW- 2 words).....	20
	ETA register (RW- 2 words).....	20
	BIN_ENABLE register (RW).....	20
	BIN_ENA_SAMPLE_STORE register (RW).....	20
	BIN_ENA_TIME_STORE register (RW).....	21
	BIN_HLIMIT registers (RW – 16 words).....	21
	BIN_SAMPLETIME registers (RW – 16 words).....	22
	BIN_THRESHOLD registers (RW – 16 words).....	22
	MKT_ACTV_ENERGY registers (RW – 2 words).....	22
	MKT_THRESHOLD_TEMP register (RW).....	22
	SHL_REF_TEMP register (RW).....	22
	SHL_Q10_TEMP register (RW – 2 words).....	23
	SHL_REF_TIME register (RW).....	23
	SHL_THRESHOLD register (RW).....	23
	STATUS register (RO).....	23
	MKT_VAL register (RO).....	24
	SHL_TIME register (RO – 2 words).....	24
	BIN_ALARM register (RO).....	24
	BIN_COUNTER registers (RO - 16 words).....	24
	LAST_SAMPLE_VALUE register (RO).....	24
	SAMPLES_NUM register (RO).....	25
	SHIPPING_DATE register (RO- 2 words).....	25
	STOP_DATE register (RO- 2 words).....	25
	USER_AREA registers (RW - 28 words).....	25
	Registers use example.....	26
<b>4</b>	<b>TECHNICAL SPECIFICATIONS.....</b>	<b>28</b>
	Technical Specification.....	28
	Air Link Protocol Characteristic.....	29
	Physical Layer.....	29
	Mechanical Specification.....	30
<b>5</b>	<b>TEMPERATURE MEASUREMENT TRACEABILITY.....</b>	<b>31</b>
	Temperature Accuracy Measurement.....	31
<b>6</b>	<b>REGULATORY COMPLIANCE.....</b>	<b>32</b>
	FCC Compliance.....	32
	CE Compliance.....	32
	Enclosure degree of protection.....	32
	RoHS EU Directive.....	32
	RT0005 CE Declaration of Conformity.....	33

## List of Figures

Fig. 1.1: easy2log <sup>®</sup> RT0005 UHF Semi-Passive Logger Tag.....	6
Fig. 1.2: easy2log <sup>®</sup> RT0005ET UHF Semi-Passive Logger Tag with external probe .....	6
Fig. 2.1: Frozen example, histogram view .....	11
Fig. 2.2: Frozen example, time vs. temperature view.....	11
Fig. 2.3: Cooled example, histogram view .....	12
Fig. 2.4: Cooled example, time vs. temperature view .....	13
Fig. 3.1: TID memory bank structure .....	17
Fig. 3.2: RESERVED memory bank structure .....	17
Fig. 5.1: Temperature measurement traceability chain .....	31

## List of Tables

Tab. 2.1: Led Indication and sensor status .....	9
Tab. 2.2: Example of histogram bins for frozen food .....	10
Tab. 2.3: Example of histogram bins for cooled food .....	12
Tab. 3.1: Standard Gen2 memory map.....	16
Tab. 3.2: User Memory map .....	19
Tab. 3.3: Temperature/Time memory organization .....	21
Tab. 4.1: easy2log <sup>®</sup> RT0005 technical specification .....	28

# 1 INTRODUCTION

## Product Description

CAEN RFID easy2log<sup>®</sup> RT0005 is a low cost, semi-passive UHF logger tag that allows to monitor temperature sensitive products like perishable foods and pharmaceuticals, during transportation and storage. The combination of the high resolution sensor, the large memory size and the standard RFID interface permits to realize effective track and trace solutions for the cold-chain.

The RT0005 can be used with standard UHF RFID readers available on the market without requiring any additional equipment thanks to its compatibility with the EPC Global C1G2 and ISO18000-6C standards.

The tag can be configured to store temperature samples in intervals from 1 second to 18 hours in the internal memory that can contain up to 3,958 samples. The user can define up to 16 temperature ranges with independent threshold alarms for a very accurate control of the temperature excursions. The tag can be started either using a button or via standard RFID commands.

The tag is also able to calculate the Mean Kinetic Temperature and user configurable remaining shelf life time as well as generate alarms in case these parameters exceeded user defined thresholds.

The RT0005 RFID logger can be used for multiple shipments thanks to the long battery life and the reset function thus allowing to reduce the total cost of the solution and anticipate the ROI.



Fig. 1.1: easy2log<sup>®</sup> RT0005 UHF Semi-Passive Logger Tag

In the Mod. RT0005ET the sensor is placed on an external probe so it is possible to measure temperature even inside a shielded box where the RFID field cannot get through.



Fig. 1.2: easy2log<sup>®</sup> RT0005ET UHF Semi-Passive Logger Tag with external probe

The RT0005 tag is included in all our RFID Reader Development Kits.

RFID Reader Development Kits allow to get acquainted with reader performances, from simple testing of RFID features to full implementation of middleware and custom applications.

These Kits include Reader, Antenna, Tags, Software, Documentation and Cabling. Everything you need to get started on UHF RFID.

## Ordering Options

	Code	Description
Tag	<a href="#">WRT0005XAAAA</a>	<a href="#">RT0005 - Temperature logger UHF semi-passive tag(EPC C1G2) Blistered</a>
	<a href="#">WRT0005ETAAA</a>	<a href="#">RT0005ET - UHF Temperature tag (EPC C1G2) with external probe</a>
Development Kit	WA528BXDKAAA	A528BBDK - Development kit with A528B reader, antennas, cable and demo tags
	WR1270CXDKAA	R1270C - Development kit with reader, adapter, antennas, cable and demo tags
	WR1230CBDKEU	R1230CBDK - Development kit with Quark reader, antenna, tags
	WR4301PDKAAA	R4301PDK - Development kit with R4301P reader, antenna, cable, power supply and demo tags
	WR4301PDKGPR	R4301PDKG - Development kit with R4301P GPRS reader, antenna, cable, power supply and demo tags
	WR4301PDKWFI	R4301PDKW - Development kit with R4301P WIFI reader, antenna, cable, power supply and demo tags

# 2 FUNCTIONAL DESCRIPTION

## Main Features

- EPC C1G2 (ISO18000-6C) Compatible
- Frequency range: 860 MHz ÷ 928 MHz
- Read range: approx. 10m in air @ 2W ERP
- Unique TID plus long EPC code (512 bit)
- Memory capacity: 4k samples (8 Kbyte)
- Multiple programmable sampling interval
- Multiple programmable temperature thresholds
- Multiple programmable alarms
- Temperature Histogram function
- Mean Kinetic Temperature function
- Remaining Shelf Life function
- Easy to use manual interface
- Typical usage time: 1 year
- Typical storage time: 6 months
- Temperature range: -20°C to +70°C
- Accuracy : ±0.5°C
- Dimensions: 107 x 107 x 6.6 mm<sup>3</sup>
- Enclosure degree of Protection IP67
- Battery charge status monitoring through RF or manual interface

## Operating states

easy2log<sup>®</sup> RT0005 tag behaves according to the following operating states:

**Stand-by.** Stand-by is the starting state of the tag. In this state the tag respond to reader interrogations, the log memory is empty and the internal clock is not started. This is the lower power consumption state.

**Idle.** The tag is in Idle state when the internal clock is running, the memory is empty and the tag is waiting for a start logging command. The start command can be issued either by an RFID command or by the button.

**Active.** The tag enters in Active state after having received the start logging command, in this state the tag wakes up at defined intervals in order to acquire temperature samples and, eventually, it stores those samples inside the log memory.

**Sleep.** The tag enters in the Sleep state at the end of a logging activity. Differently from the Idle state, in Sleep state the tag's log memory is not empty and it is retained until a reset command is issued.



## Manual interface behaviour

The easy2log<sup>®</sup> RT0005 tag has a simple manual interface that includes a button, a green LED and a red LED that, depending on the configuration, permits to check the status of the alarms and to start/stop the logging activity. By default, the button can be used only to check the status of the tag but not to start/stop the logging activity. Start/stop function can be activated setting the Button Enable (BE) bit in the CONTROL register.

The manual interface behaves as follows:

- Pressing the red button quickly (less than 2 second) activates the check status function:
  - If the battery level is still sufficient for the logging activity and no alarms are active the green LED will stay lit for 2 seconds.
  - If the battery level is still enough for the logging activity but there are active alarms the red LED will stay lit for 2 seconds. The alarms causing the red LED to light are:
    - Memory full (see MEMFULL bit in STATUS register description).
    - ETA alarm (see ETA\_ALARM bit in the STATUS register description).
    - Bin counters alarm (see BIN\_ALMR bit in STATUS register description).
    - Mean Kinetic alarm (see MKT\_ALARM bit in the STATUS register description).
    - Shelf life alarm (see SHL\_ALARM bit in the STATUS register description).
  - If the battery has not enough charge to continue the logging activity the red or green LED will blink for 2 seconds (the green one in the case of no alarms, red in case of some alarms).

LED INDICATION	SENSOR STATUS
Green and red light up	Ready to start
Green blinks slowly	Started/no alert
Red blinks slowly	Started/alert
Green lights up	Stopped/no alert
Red lights up	Stopped/alert

**Tab. 2.1: Led Indication and sensor status**

If the BE bit is 1 (Start/stop function activated), in addition to the behaviour previously described, the manual interface has the following features:

- The start of the logging activity can be performed in the following way:
  - Hold down the button until the green LED starts blinking.
  - Release the button and press again within 5 seconds for confirmation
  - If the command is accepted the green LED will blink slowly.
  - The acquisition is started.

And, if the SD bit is 0, also the following operation is allowed:

- The stop of the logging activity can be performed in the following way:
  - Hold down the button until the red LED starts blinking.
  - Release the button and press again within 5 seconds for confirmation.
  - If the command is accepted the red LED will light up.
  - The acquisition is stopped.

## Histogram functionality description

The easy2log<sup>®</sup> RT0005 tag allows to define up to 16 different histograms bins. The user is able to decide the upper and lower temperature limits for each bin: the lower limit of each bin is equal to the upper limit of the previous bin while the upper limit can be defined by the user (BIN\_HLIMIT\_[X] where X is the index of the histogram bin). The first bin starts always from the lower temperature limit of the tag while the upper limit of the last bin is always the higher temperature limit of the tag.

Each histogram bin has a bit that allows to enable/disable the counter for the bin (BIN\_ENABLE register). If the bin is enabled, the corresponding counter (BIN\_COUNTER[X]) is incremented when the sampled temperature value is greater to the lower limit and less or equal than the higher limit. If the bin is not enabled the temperature values in the interval defined by the corresponding bin are not counted.

For each bin it is possible to define a threshold value (BIN\_THRESHOLD\_[X]) in order to generate an alarm when the counter is greater or equal to the threshold value. The generation of the alarm can be disabled setting the threshold to 0xFFFF (default value).

It is also possible to define a different sampling interval for each different bin in order to permit a fine grained sampling in critical temperature ranges and a more relaxed sampling in standard temperature conditions. The sampling interval time is modified after the detection of the first temperature sample value in a new bin (if the value of the temperature falls in the same bin the sampling time does not change, if it falls in a new bin the sampling time is updated with the value of the BIN\_SAMPLETIME[X] register where X is the index of the new bin).

Histogram bins configuration can be used also to control the storage of the samples inside the logging memory: for each bin (if enabled) the user can choose to store or not in the memory the temperature value (depending on the state of the corresponding bit in the BIN\_ENA\_SAMPLE\_STORE register) and the time stamp (depending on the state of the corresponding bit in the BIN\_ENA\_TIME\_STORE). Disabling the sample storage for accepted temperature ranges can provide a better handling of long term deliveries due to the memory saving. In this case it is necessary to enable the storage of absolute timestamps together with the samples out of the acceptance range in order to keep track of the chronological sequence. At the same time, the bin counter can be enabled also for the accepted temperature range in order to have a feedback on the temperature trend for the entire delivery. Due to the availability of a large number of bins, the accepted range can be divided in more than one bin in order to have finer grained information on the temperature trend.

### Examples of usage:

Let suppose that the user wants to monitor the temperature trend for frozen food, we can define some histogram bins as follows:

Bin	Low Limit (°C)	High Limit (°C)	Enabled	Threshold	Store Samples	Sampling Interval (min.)
0	-20	-15	Yes	0	Yes	15
1	-15	-10	Yes	3	Yes	10
2	-10	0	Yes	2	Yes	5
3	0	70	Yes	1	Yes	1

**Tab. 2.2: Example of histogram bins for frozen food**

With this configuration the tag generates an alarm if the temperature was between -15°C and -10°C for a minimum amount of time ranging from 20 min. to 34 min. and 59 sec. or if it was between -10 °C and 0 °C for a minimum amount of time ranging from 5 min. to 14 min. and 59 sec. or greater than 0 °C just for a minimum amount of ranging from 1 sec. to 4 min. and 59 sec. (see Fig. 2.1 and Fig. 2.2)

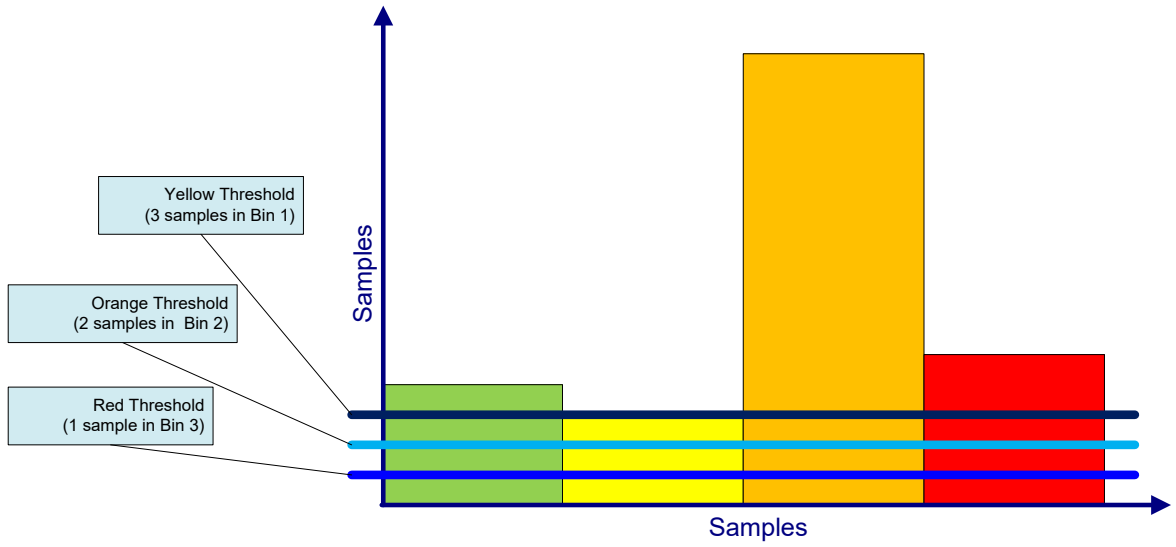

Fig. 2.1: Frozen example, histogram view

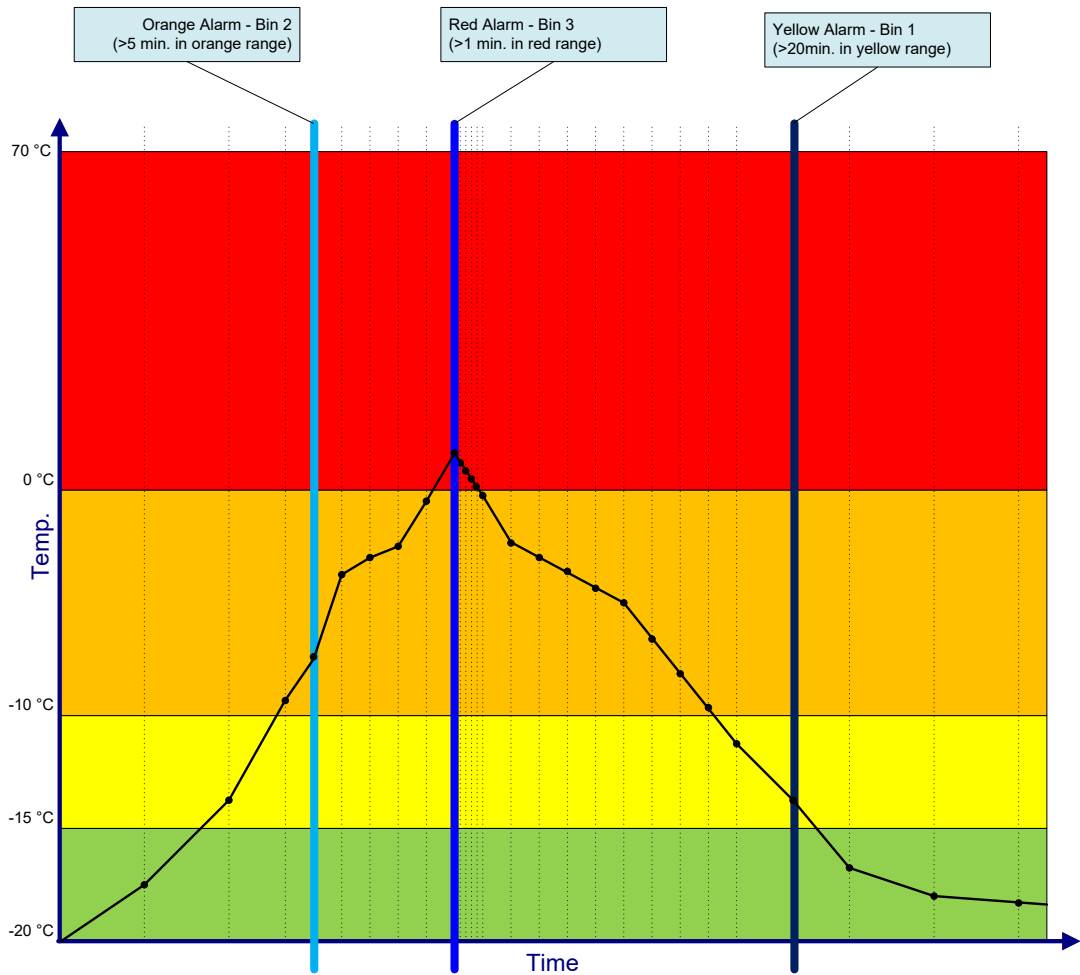

Fig. 2.2: Frozen example, time vs. temperature view

As another **example** suppose that the user wants to monitor the temperature trend for cooled food, we can define some histogram bins as follows:

Bin	Low Limit (°C)	High Limit (°C)	Enabled	Threshold	Store Samples	Sampling Interval (min.)
0	-20	-5	Yes	5	Yes	5
1	-5	0	Yes	0	No	10
2	0	70	Yes	3	Yes	5

**Tab. 2.3: Example of histogram bins for cooled food**

With this configuration the tag generates an alarm if the temperature rise between -20°C and -5°C for a minimum amount of time ranging from 20 min. to 29 min. and 59 sec. or if it is in the range between 0°C and 70°C for a minimum amount of time ranging from 5 min. to 14 min. and 59 sec. (see Fig. 2.3 and Fig. 2.4). In this example the samples are not stored in the log memory in order to save memory space.

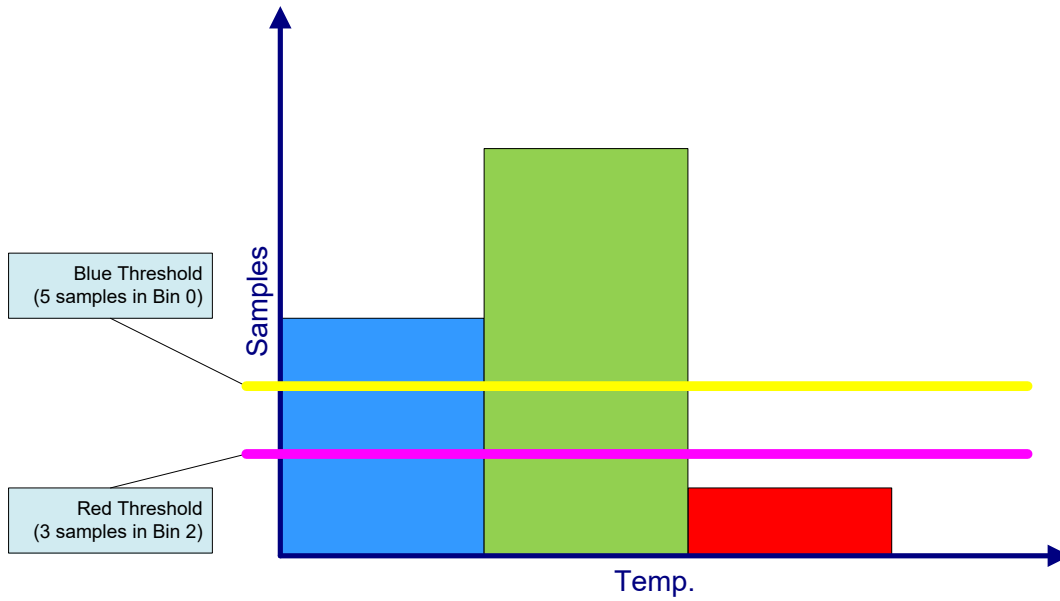

**Fig. 2.3: Cooled example, histogram view**

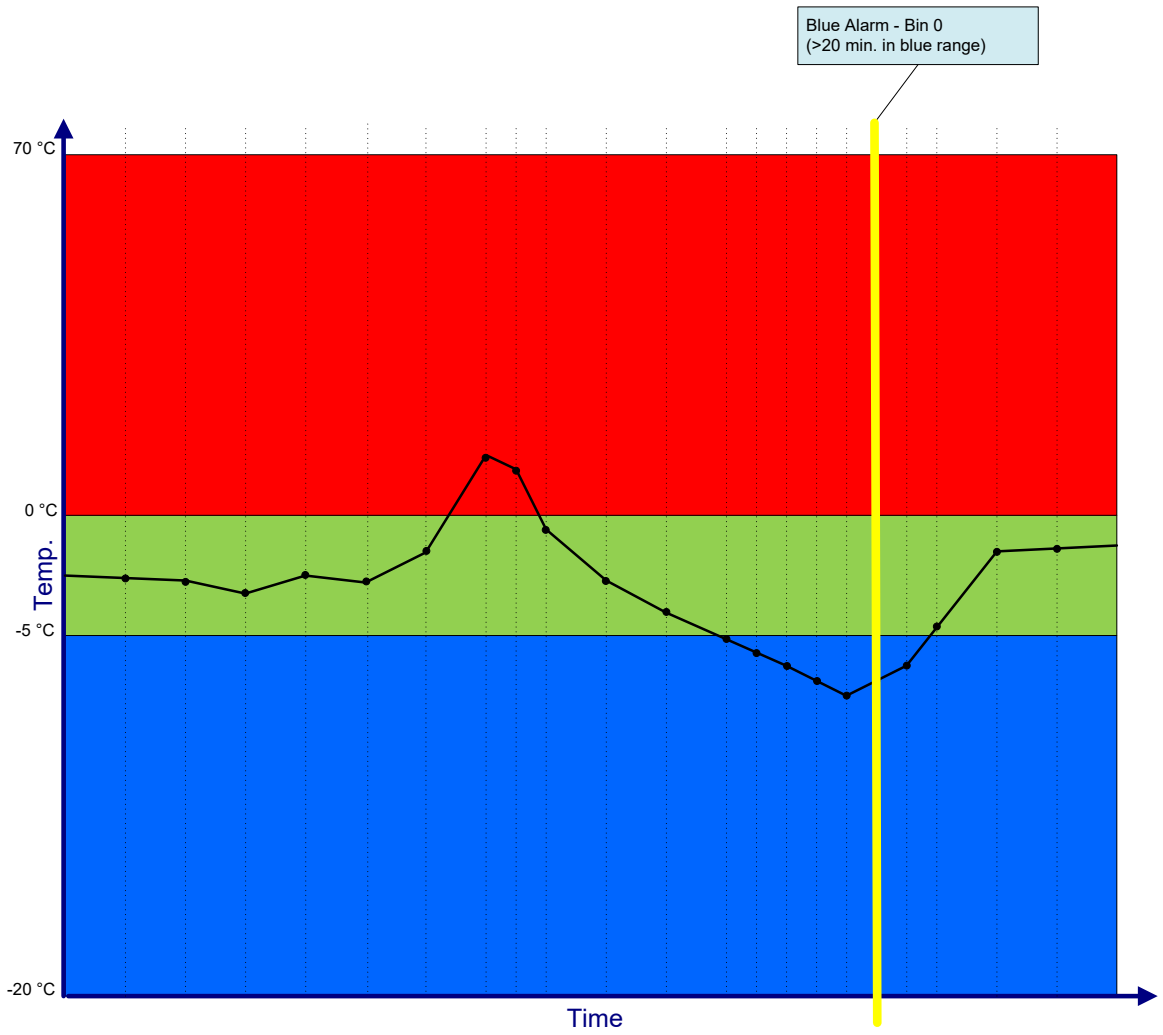

Fig. 2.4: Cooled example, time vs. temperature view

## Mean Kinetic Temperature calculation

The Mean Kinetic Temperature (MKT) is a simplified way of expressing the overall effect of temperature fluctuations during storage or transit of perishable goods. MKT is useful in order to monitor the status of perishable items during a shipment. The RT0005 tag is able to update the MKT every time it samples a new temperature. The MKT function can be enabled or disabled toggling the state of the MKTE flag in the CONTROL register.

MKT is calculated using the following formula:

$$MKT = \frac{\Delta H}{R} \left( \frac{1}{- \ln \left( \frac{e^{\frac{-\Delta H}{RT_1}} + e^{\frac{-\Delta H}{RT_2}} + \dots + e^{\frac{-\Delta H}{RT_n}}}{n} \right)} \right) \quad (1)$$

where  $\Delta H$  is the MKT activation energy constant expressed in J/mol,  $R$  is the universal gas constant,  $n$  is the number of samples and  $T_n$  is the temperature of the different samples expressed in °K.

The user can set a threshold value for the MKT; if the MKT exceeds the threshold, the tag generates an alarm setting to 1 the MKT\_ALARM bit in the STATUS register.

The current MKT value can be obtained reading the MKT\_VAL register while the threshold can be set writing the desired value in the MKT\_THRESHOLD register.

## Remaining Shelf Life calculation

Shelf Life is the length of time that perishable items are given before they are considered unsuitable for sale or consumption. For many products the spoilage rate increase of a perishable good is an exponential function of temperature.

As well as the Mean Kinetic Temperature, the remaining Shelf Life calculation is useful in order to monitor the status of an item during the shipment. The RT0005 tag is able to calculate the remaining Shelf Life using a linear approximation of the Arrhenius algorithm every time it samples a new temperature. The remaining Shelf Life calculation can be enabled or disabled toggling the state of the ARRE flag in the CONTROL register.

The remaining Shelf Life is expressed in hours and is calculated with the following formula:

$$SHL_n = SHL_{ref} - \sum_n \left( Q_{10}^{\frac{(T_n - T_{ref})}{10}} * t_n \right) \quad (2)$$

where  $SHL_{ref}$  is the Shelf Life reference expressed in hours,  $T_n$  is the temperature of the different samples expressed in °C,  $T_{ref}$  is the reference temperature expressed in °C,  $Q_{10}$  (unit less number) is defined as the ratio of the reaction rate constants at temperatures differing by 10 °C from the reference temperature and  $t_n$  is the sampling interval expressed in hours for the selected bin.

The user can set a threshold value for the remaining Shelf Life; if the remaining Shelf Life is lower than the threshold, the tag generates an alarm setting to 1 the SHL\_ALARM bit in the STATUS register. The remaining Shelf Life value can be obtained reading the SHL\_TIME register while the threshold can be set writing the desired value in the SHL\_THRESHOLD register.

The remaining Shelf Life value can be obtained reading the SHL\_TIME register while the threshold can be set writing the desired value in the SHL\_THRESHOLD register.

## Battery measurement and behaviour

The RT0005 tag includes a battery measurement circuitry that allows to control the battery charge level.

Four battery charge levels are defined: Full (3), Normal (2), Low (1), Empty (0); values can be obtained reading the BAT\_LSBIT and BAT\_MSBIT in the STATUS register. The RT0005 tag behave normally when the battery is at the Full or Normal battery level, while it is automatically put in Sleep state when the level reach the Low value.

When the battery level status is Low (1) or Empty (0) the battery level is considered critical so the condition is reported by the manual interface as described in the relevant paragraph.

# 3 MEMORY DESCRIPTION

## Address space

The RT0005 tag implements a standard Gen2 memory map; it has 4 memory banks: RESERVED, EPC, TID and USER.

Memory Banks are defined as follows:

Bank 11b	USER
Bank 10b	TID
Bank 01b	EPC
Bank 00b	RESERVED

**Tab. 3.1: Standard Gen2 memory map**

Below a brief explanation of memory banks' content (all the address are specified 16bit word bounded):

**EPC.** This bank contains 16 bit CRC-16 and 16 bit PC field according to the standard and additional 496 bit for EPC storing. The EPC bank contains the EPC of the RT0005 product that is composed by the CAEN company prefix, the RT0005 object type and a serial number. The EPC is formatted as a SGTIN-96 code.

**TID.** This bank contains the Class Identifier, the Mask-Designer Identifier, the Model Number of the chip as requested by the standard, plus a 32 bit long Serial Number (see below for details) and the assembly and chip revision. Total size of the TID field is 64 bits. The TID memory bank contains also a 32 bit SAM field used to store the address of the sensor characteristics table as defined by the ISO18000-6REV1 draft standard and additional 110 bytes for user purposes. The TID and SAM fields are permalocked by the manufacturer while the additional user space is not locked by default but it can be locked using the standard Gen2 lock mechanism.

Free memory space		3C <sub>h</sub>
.....		
Free memory space		0A <sub>h</sub>
Assembly Revision		09 <sub>h</sub>
Chip Revision		08 <sub>h</sub>
RFU (Reserved for Future Use)		06 <sub>h</sub> -07 <sub>h</sub>
SAM (31...16)		05 <sub>h</sub>
SAM (15...0)		04 <sub>h</sub>
Serial Number (31 ... 16)		03 <sub>h</sub>
Serial Number (15 ... 0)		02 <sub>h</sub>
Model Number (11 ... 0) 00000000110 <sub>b</sub>	MDID (11 ... 8) 0000 <sub>b</sub>	01 <sub>h</sub>



Mask Designer ID (7... 0) 00010010 <sub>b</sub>	Class ID 11100010 <sub>b</sub>	00 <sub>h</sub>
----------------------------------------------------	-----------------------------------	-----------------

**Fig. 3.1: TID memory bank structure**

**RESERVED.** This bank contains the 32 bit Kill password and the 32 bit Access password according to the EPC Class 1 Gen 2 standard. The RESERVED memory bank contains additional 56 bytes for user purposes. The locking mechanism of the user data field in the RESERVED memory bank is linked to the locking of the Access password field (i.e. user data is locked when the access password is locked). Data stored in these 56 bytes are protected also for reading as the password fields are, when locked.

Free memory space	1F <sub>h</sub>
.....	
Free memory space	04 <sub>h</sub>
Access Password (31 ... 16)	03 <sub>h</sub>
Access Password (15 ... 0)	02 <sub>h</sub>
Kill Password (31 ... 16)	01 <sub>h</sub>
Kill Password (15 ... 0)	00 <sub>h</sub>

**Fig. 3.2: RESERVED memory bank structure**

**USER MEMORY.** This bank contains all the configuration registers and the logging memory. The total memory bank's size is 8 Kbyte (see next chapter for details), 220 bytes are needed for the configuration and status register, 56 bytes are free for user purposes and 7914 are allocated for the log area.

## User Memory map

Register	Address	Op.	Default
CONTROL	0x0A	RW	0x0010
SAMPLING_DELAY	0x0B	RW	0x0E10
INIT_DATE_L	0x0C	RW	0x0000
INIT_DATE_H	0x0D	RW	0x0000
ETA_L	0x0E	RW	0x0000
ETA_H	0x0F	RW	0x0000
BIN_ENABLE	0x10	RW	0x0001
BIN_ENA_SAMPLE_STORE	0x11	RW	0xFFFF
BIN_ENA_TIME_STORE	0x12	RW	0x0000
BIN_HLIMIT_0	0x13	RW	0x08C0
BIN_HLIMIT_1	0x14	RW	0x0000
...	...	..	0x0000
BIN_HLIMIT_15	0x22	RW	0x0000
BIN_SAMPLETIME_0	0x23	RW	0x0258
BIN_SAMPLETIME_1	0x24	RW	0x0000
...	...	..	0x0000
BIN_SAMPLETIME_15	0x32	RW	0x0000
BIN_THRESHOLD_0	0x33	RW	0xFFFF
BIN_THRESHOLD_1	0x34	RW	0xFFFF
...	...	..	0xFFFF
BIN_THRESHOLD_15	0x42	RW	0xFFFF
MKT_ACTV_ENERGY_L	0x43	RW	0x0000
MKT_ACTV_ENERGY_H	0x44	RW	0x0000
MKT_THRESHOLD_TEMP	0x45	RW	0x0000
SHL_REF_TEMP	0x46	RW	0x0000
SHL_Q10_TEMP_L	0x47	RW	0x0000
SHL_Q10_TEMP_H	0x48	RW	0x0000
SHL_REF_TIME	0x49	RW	0x0000
SHL_THRESHOLD	0x4A	RW	0x0000
RFU	0x4B	--	--
RFU	0x4C	--	--
RFU	0x4D	--	--
RFU	0x4E	--	--
RFU	0x4F	--	--
RFU	0x50	--	--
STATUS	0x51	RO	--
MKT_VAL	0x52	RO	0x0000
SHL_TIME_L	0x53	RO	0x0000
SHL_TIME_H	0x54	RO	0x0000
BIN_ALARM	0x55	RO	0x0000
BIN_COUNTER_0	0x56	RO	0x0000
BIN_COUNTER_1	0x57	RO	0x0000
...	...	..	0x0000
BIN_COUNTER_15	0x65	RO	0x0000
LAST_SAMPLE_VALUE	0x66	RO	0x0000
SAMPLES_NUM	0x67	RO	0x0000
RFU	0x68	--	--
RFU	0x69	--	--
SHIPPING_DATE_L	0x6A	RO	0x0000
SHIPPING_DATE_H	0x6B	RO	0x0000
STOP_DATE_L	0x6C	RO	0x0000
STOP_DATE_H	0x6D	RO	0x0000
USER_AREA_0	0x6E	RW	--
USER_AREA_1	0x6F	RW	--
...	..	..	--
USER_AREA_27	0x89	RW	--
LOG_AREA_0	0x8A	RO	--
.....	.....	...	--

Register	Address	Op.	Default
LOG_AREA_3956	0xFFE	RO	--

Tab. 3.2: User Memory map

## Register description

### CONTROL register (RW)

Register	Address	Op.	Default
CONTROL	0x0A	RW	0x0010

The register is composed by the following fields:

15..12	11	10..8	7	6	5	4	3	2	1	0
RFU	SD	RFU	ARRE	MKTE	RFSL_MBIT	RFSL_LBIT	DE	LE	BE	RST

**RST (RW) - Reset bit:** Reset bit is used to erase all the log memory and reset all the memory pointers and counters included the histogram bins. The value of the bit remain set until the reset operation is performed then it returns to 0. Default value is 0.

**BE (RW) - Button\_Enable bit:** if the Button\_Enable bit is set the RT0005 button can be used to start and to stop the logging activity. Default value is 0.

**LE (RW) - Logging\_Enable bit:** Logging\_Enable bit is used to enable(1)/disable(0) the logging activity. If the Button\_Enable bit is set the Logging\_Enable bit can be set/reset using the manual interface. Once stopped, the logging activity can be restarted only after the tag has been reset using the RST bit. Default value is 0.

**DE (RW) - Delay\_Enable bit:** Delay\_Enable bit is used to enable(1)/disable(0) the usage of the SAMPLING\_DELAY register. If enabled, the first sample's acquisition is done SAMPLING\_DELAY second after the start of the logging activity. Default value is 0.

**RFSL (RW) - RF\_Sensitivity\_Level:** RF\_Sensitivity\_Level register is used to set the sensitivity level of the radio frequency front-end. Sensitivity can be set on 3 different levels: 3 = maximum sensitivity level, 1 = minimum sensitivity level. Default value is 1.

**MKTE (RW) - Mean\_Kinetic\_Enable bit:** Mean\_Kinetic\_Enable bit is used to enable(1)/disable(0) the Mean Kinetic Temperature calculation. Default value is 0.

**ARRE (RW) - Arrhenius\_Enable bit:** Arrhenius\_Enable bit is used to enable(1)/disable(0) the calculation of the remaining Shelf Life (SHL\_TIME) of the product using the Arrhenius equation with linear approximation. Default value is 0.

**SD (RW) - Stop\_Disable bit:** if the Stop\_Disable bit is set the RT0005 button cannot be used to stop the logging activity. Default value is 0.

### SAMPLING\_DELAY register (RW)

Register	Address	Op.	Default
SAMPLING_DELAY	0x0B	RW	0x0E10

Sampling\_Delay register defines the delay, in seconds, of the first acquisition after the start of the logging activity. Register value range is 0 to 65535; default value is 3600 (seconds) corresponding to 1 hour delay. The sampling delay is activated if the corresponding bit on the CONTROL register (DE) is enabled.

## INIT\_DATE register (RW- 2 words)

Register	Address	Op.	Default
INIT_DATE_L	0x0C	RW	0x0000
INIT_DATE_H	0x0D	RW	0x0000

The Init Date register is used to keep track of time and it is expressed in Unix time format. Default register's value is 0 that corresponds to midnight (UTC) January, 1 1970. If date value is 0, the internal timer is not active. When this register is set to a non-zero value the internal 32 bit register timer starts. The INIT\_DATE register MUST be set AFTER the RESET operation on the tag. INIT\_DATE\_L must be written before INIT\_DATE\_H. The INIT\_DATE register is set to 0 after a reset operation.

## ETA register (RW- 2 words)

Register	Address	Op.	Default
ETA_L	0x0E	RW	0x0000
ETA_H	0x0F	RW	0x0000

The Estimated Time of Arrival register (expressed in seconds) defines the maximum time, computed from shipping date, required to arrive at destination. If the logging is not stopped before the ETA is reached an alarm is generated. If the value of this register is 0 the ETA alarm feature is disabled. Default value of ETA register is 0.

## BIN\_ENABLE register (RW)

Register	Address	Op.	Default
BIN_ENABLE	0x10	RW	0x0001

The register is composed by the following fields:

15	...	2	1	0	
BIN15_EN	...	BIN02_EN	BIN01_EN	BIN00_EN	
0	0	0	0	1	<b>Default</b>

BINX\_EN Enable(1)/Disable(0) the counter for the corresponding histogram bin.

## BIN\_ENA\_SAMPLE\_STORE register (RW)

Register	Address	Op.	Default
BIN_ENA_SAMPLE_STORE	0x11	RW	0xFFFF

The register is composed by the following fields:

15	...	2	1	0	
BIN15_EN	...	BIN02_EN	BIN01_EN	BIN00_EN	
1	1	1	1	1	<b>Default</b>

BINX\_EN: if the BINX\_EN bit (X=0..15) is set to 1 all the sampled data values which are in the range of bin X are saved into the logging memory. Default condition is all flags set to 1.

## BIN\_ENA\_TIME\_STORE register (RW)

Register	Address	Op.	Default
BIN_ENA_TIME_STORE	0x12	RW	0x0000

The register is composed by the following fields:

15	...	2	1	0	Default
BIN15_EN	...	BIN02_EN	BIN01_EN	BIN00_EN	
0	0	0	0	0	

BINX\_EN: if the BINX\_EN bit (X = 0..15) is set to 1 the timestamps (2 words - Unix time format) of sampled values which are in the range of bin X are saved into the logging memory. Default condition is 0 for all flags.

**Example:** In case both the sample value and the sample time need to be stored in the log area the sequence of the logged data in the memory is the following:

Address	Data (16 bit)
0x08A	Sample 1: Temperature value
0x08B	Sample 1: Time (low) <sup>(*)</sup>
0x08C	Sample 1: Time (high) <sup>(*)</sup>
0x08D	Sample 2: Temperature value
...	....

(\*)Time is expressed in Unix format and need 2 words for a single sample.

**Tab. 3.3: Temperature/Time memory organization**

## BIN\_HLIMIT registers (RW – 16 words)

Register	Address	Op.	Default
BIN_HLIMIT_0	0x13	RW	0x08C0
BIN_HLIMIT_1	0x14	RW	0x0000
...	...	..	0x0000
BIN_HLIMIT_15	0x22	RW	0x0000

These registers are used to set the upper limit for the corresponding histogram bin. The lower level corresponds to the upper level of the previous bin. The lower level of the first bin is fixed to the lower limit of the sensor.

The temperature T in °C is expressed in fixed point 8.5 notation  $T_{fixedpoint}$  using the formula:

$$T_{fixedpoint} = \begin{cases} T * 32 & \text{if } 0^{\circ}C \leq T \leq 70^{\circ}C \\ 8192 + T * 32 & \text{if } -20^{\circ}C \leq T < 0^{\circ}C \end{cases} \quad (3)$$

Some sample values are shown in the table below:

T(°C)	$T_{fixedpoint}$
-20	7552
-0,25	8184
0	0
70	2240

## BIN\_SAMPLETIME registers (RW – 16 words)

Register	Address	Op.	Default
BIN_SAMPLETIME_0	0x23	RW	0x0258
BIN_SAMPLETIME_1	0x24	RW	0x0000
...	...	..	0x0000
BIN_SAMPLETIME_15	0x32	RW	0x0000

These registers are used to define the sample interval to apply for the next acquisitions in the corresponding bin. The value is expressed in seconds.

## BIN\_THRESHOLD registers (RW – 16 words)

Register	Address	Op.	Default
BIN_THRESHOLD_0	0x33	RW	0x0000
BIN_THRESHOLD_1	0x34	RW	0x0000
...	...	..	0x0000
BIN_THRESHOLD_15	0x42	RW	0x0000

These registers represent the threshold value for the alarm (expressed in counts) on the corresponding bin. If the bin counter value is greater or equal than the threshold value the alarm bit for the corresponding bin is set.

## MKT\_ACTV\_ENERGY registers (RW – 2 words)

Register	Address	Op.	Default
MKT_ACTV_ENERGY_L	0x43	RW	0x0000
MKT_ACTV_ENERGY_H	0x44	RW	0x0000

The value, expressed in floating point 32bits (IEEE-754) notation, represents the Mean Kinetic activation energy and it is expressed in J/mol. The map between the floating point fields and the two registers is reported below:

Sign	Exponent	Mantissa	
31	30..23	22..16	15..0
MKT_ACTV_ENERGY_H		MKT_ACTV_ENERGY_L	

## MKT\_THRESHOLD\_TEMP register (RW)

Register	Address	Op.	Default
MKT_THRESHOLD_TEMP	0x45	RW	0x0000

This register provides the threshold temperature value for the alarm of the Mean Kinetic algorithm. If the Mean Kinetic value is greater than the threshold value the alarm bit is set. The temperature in °C is expressed in fixed point 8.5 notation using the formula (3).

## SHL\_REF\_TEMP register (RW)

Register	Address	Op.	Default
SHL_REF_TEMP	0x46	RW	0x0000

Shelf life reference temperature expressed °C. The temperature in °C is expressed in fixed point 8.5 notation using the formula (3).

## SHL\_Q10\_TEMP register (RW – 2 words)

Register	Address	Op.	Default
SHL_Q10_TEMP_L	0x47	RW	0x0000
SHL_Q10_TEMP_H	0x48	RW	0x0000

This value, represented in floating point 32bits (IEEE-754) notation, is used to configure the Arrhenius algorithm behaviour. It is defined as the ratio of the reaction rate constants at temperatures differing by 10 °C from the reference temperature. It is a unit less number. The map between the floating point fields and the two registers is reported below:

Sign	Exponent	Mantissa	
31	30..23	22..16	15..0
SHL_Q10_TEMP_H		SHL_Q10_TEMP_L	

## SHL\_REF\_TIME register (RW)

Register	Address	Op.	Default
SHL_REF_TIME	0x49	RW	0x0000

Shelf life reference time represents the shelf life of the product if stored at the shelf reference temperature. If the SHL\_REF\_TIME value becomes smaller of the Threshold value the alarm bit is set. It is expressed in hours.

## SHL\_THRESHOLD register (RW)

Register	Address	Op.	Default
SHL_THRESHOLD	0x4A	RW	0x0000

Shelf life threshold represents the threshold value for the alarm of the Arrhenius algorithm. If the SHL\_TIME value becomes smaller of the Threshold value the alarm bit is set. It is expressed in hours.

## STATUS register (RO)

Register	Address	Op.	Default
STATUS	0x51	RO	--

The register is composed by the following fields:

15..7	6	5	4	3	2	1	0
RFU	SHL_ALRM	MKT_ALRM	BIN_ALRM	ETA_ALRM	MEMFULL	BAT_MSBIT	BAT_LSBIT

**BAT\_LS/MS\_BIT - Battery\_Level:** Battery Level is a 2 bit register representing the remaining battery capacity. Value of 3 means full capacity, value 0 means minimum capacity. The measurement is performed before each sensor acquisition. If the Battery Level value is 1 (almost discharged) the RT0005 is put automatically in Sleep state.

**MEMFULL - Memory\_Full bit:** Memory Full bit represents the status of the log memory, its value is 0 if the memory is not yet full, it is 1 if there is no more space in the log memory. If memory becomes full the RT0005 is put automatically in Sleep state. Default value is 0. MEMFULL bit is set to 0 after a reset operation.

**ETA\_ALRM - ETA\_Alarm bit:** the ETA\_Alarm bit is set to 1 when the current time exceeds the value of the SHIPPING\_DATE register plus the ETA delay register. Default value is 0. ETA\_ALRM bit is set to 0 after a reset operation.

**BIN\_ALRM - Histogram\_Alarm bit:** the Histogram Alarm bit is set to 1 when at least one of the histogram bin counters is greater than the corresponding threshold. Default value is 0. BIN\_ALRM bit is set to 0 after a reset operation.

**MKT\_ALRM:** the Mean Kinetic alarm bit is set to 1 when the mean Kinetics temperature is greater than the mean Kinetic threshold temperature. Default value is 0. MKT\_ALRM bit is set to 0 after a reset operation.

**SHL\_ALRM:** the shelf life alarm bit is set to 1 when the remaining shelf life is smaller than the shelf life threshold. Default value is 0. SHL\_ALRM bit is set to 0 after a reset operation.

## MKT\_VAL register (RO)

Register	Address	Op.	Default
MKT_VAL	0x52	RO	0x0000

MKT\_VAL register represents the current value of the Mean Kinetic Temperature. It is expressed in °C using a fixed point 8.5 notation, see formula (3). Default value is 0. MKT\_VAL register is set to 0 after a reset operation.

## SHL\_TIME register (RO – 2 words)

Register	Address	Op.	Default
SHL_TIME_L	0x53	RO	0x0000
SHL_TIME_H	0x54	RO	0x0000

This register, represented in floating point 32bits (IEEE-754) notation, provides to the user the current value of the remaining shelf life expressed in hours. Default value is 0. SHL\_TIME register is set to 0 after a reset operation.

The map between the floating point fields and the two registers is reported below:

Sign	Exponent	Mantissa	
31	30..23	22..16	15..0
SHL_TIME_H		SHL_TIME_L	

## BIN\_ALARM register (RO)

Register	Address	Op.	Default
BIN_ALARM	0x55	RO	0x0000

The register is composed by the following fields:

15	...	2	1	0	Default
BIN15_EN	...	BIN02_EN	BIN01_EN	BIN00_EN	
0	0	0	0	0	

BINX\_EN bit (X = 0..15) is set to 1 if the value of the BIN\_COUNTER\_X register is greater than the corresponding BIN\_THRESHOLD\_X register value. BIN\_ALARM register is set to 0 after a reset operation.

## BIN\_COUNTER registers (RO - 16 words)

Register	Address	Op.	Default
BIN_COUNTER_0	0x56	RO	0x0000
BIN_COUNTER_1	0x57	RO	0x0000
...	...	..	0x0000
BIN_COUNTER_15	0x65	RO	0x0000

These registers represent the number of temperature samples in the range of the corresponding bin. Default value is 0 for each counter. All the BIN\_COUNTER registers are set to 0 after a reset operation.

## LAST\_SAMPLE\_VALUE register (RO)

Register	Address	Op.	Default
LAST_SAMPLE_VALUE	0x66	RO	0x0000

It represents the last temperature value read from the sensor (even if not stored in the log memory). LAST\_SAMPLE\_VALUE register is set to 0 after a reset operation.



## SAMPLES\_NUM register (RO)

Register	Address	Op.	Default
SAMPLES_NUM	0x67	RO	0x0000

It represents the number of samples present inside the log memory. SAMPLES\_NUM register is set to 0 after a reset operation.

## SHIPPING\_DATE register (RO- 2 words)

Register	Address	Op.	Default
SHIPPING_DATE_L	0x6A	RO	0x0000
SHIPPING_DATE_H	0x6B	RO	0x0000

The Shipping Date register (expressed in the Unix time format) is used to store the time when logging was enabled (by RF or, if enabled, by the button). Default value of SHIPPING\_DATE register is 0. SHIPPING\_DATE register is set to 0 after a reset operation.

## STOP\_DATE register (RO- 2 words)

Register	Address	Op.	Default
STOP_DATE_L	0x6C	RO	0x0000
STOP_DATE_H	0x6D	RO	0x0000

The STOP\_DATE register (expressed in the Unix time format) is used to store the time when logging was stopped (by RF or, if enabled, by the button). Default value of STOP\_DATE register is 0. STOP\_DATE register is set to 0 after a reset operation.

## USER\_AREA registers (RW - 28 words)

Register	Address	Op.	Default
USER_AREA_0	0x6E	RW	--
USER_AREA_1	0x6F	RW	--
...	..	..	--
USER_AREA_27	0x89	RW	--

User area is a set of 28 words registers for user defined data storage.

## Registers use example

Let suppose that the user wants to configure the tag as described in the first example of the paragraph, in the table below is presented again the scenario that shall be realized:

Bin	Low Limit (°C)	High Limit (°C)	Enabled	Threshold	Store Samples	Sampling Interval (min.)
0	-20	-15	Yes	0	Yes	15
1	-15	-10	Yes	3	Yes	10
2	-10	0	Yes	2	Yes	5
3	0	70	Yes	1	Yes	1

First of all let's set the upper limit of each histogram bin. The upper limits in the example are -15, -10, 0 and 70 °C. The data need to be converted in fixed point 8.5 notation format using the formula (3):

T(°C)	T <sub>fixed</sub>	Register <sub>hex</sub>
-15	7712	HLIMIT[0] = 0x1E20
-10	7872	HLIMIT[1] = 0x1EC0
0	0	HLIMIT[2] = 0x0000
70	2240	HLIMIT[3] = 0x08C0

All the 4 Bins used in the example need to be enabled in the BIN\_ENABLE register, the bits corresponding shall be set to 1:

**BIN\_ENABLE = 0x000F**

The Threshold value register shall be filled with the example value:

**BIN\_THRESHOLD[0] = 0x0000**

**BIN\_THRESHOLD[1] = 0x0003**

**BIN\_THRESHOLD[2] = 0x0002**

**BIN\_THRESHOLD[3] = 0x0001**

The sampling interval time, expressed in minutes, must be converted in seconds for the correct setting of the BIN\_SAMPLETIME register:

Min.	Sec.	Register
15	900	BIN_SAMPLETIME[0] = 0x0384
10	600	BIN_SAMPLETIME[1] = 0x0258
5	300	BIN_SAMPLETIME[2] = 0x012C
1	60	BIN_SAMPLETIME[3] = 0x003C

In this example, the samples have to be stored in the user memory hence the BIN\_SAMPLE\_STORE register flags have to be set for the corresponding bins:

**BIN\_SAMPLE\_STORE = 0x000F**

The samples' timestamps do not need to be saved (it is not required by the example) hence the BIN\_SAMPLE\_TIME register's flags shall be disabled:

**BIN\_SAMPLE\_TIME = 0x0000**

The Mean Kinetic Temperature and the Shelf Life registers can be left to the default value since we don't need to use it.

In order to activate the tag and put it in Idle state the initial date configuration register (INIT\_DATE) shall be written with a non-zero value and the tag shall be reset using the dedicated bit in the CONTROL register. In this state the internal clock is active and the tag is waiting for a start logging command (LE in the STATUS register).

Once the LE bit toggle to 1 (start logging) the tag wait for the SAMPLING\_DELAY expiration (if the Delay Enable flag is enabled and SAMPLING\_DELAY is different than 0) then it starts the acquisition of the temperature samples.

During the acquisition the tag samples the temperature each BIN\_SAMPLETIME[x] seconds (where x is the bin index corresponding to the last temperature sample).

Let now suppose that the temperature has been sampled more than 3 times in the first bin; in this case an alarm must be generated. The status of the register will be:

<b>STATUS</b>	= <b>0x0013</b> (BIN_ALARM flag active and battery status Full)
<b>BIN_ALARM</b>	= <b>0x0002</b> (alarm flag set corresponding to the first bin).
<b>BIN_COUNTER[1]</b>	= <b>0x0003</b> (3 samples counted in the first bin)

# 4 TECHNICAL SPECIFICATIONS

## Technical Specification

<b>Tag Type</b>	Semipassive
<b>Data Points</b>	4000
<b>Temperature operating range</b>	-20°C to +70°C
<b>Temperature Accuracy</b>	±0.5°C typical
<b>Monitoring Time Span</b>	Up to 5 years
<b>Time Accuracy</b>	<0.01% error
<b>RFID Interface</b>	UHF EPC Class1 Gen2/ISO 18000-6C compatible <sup>1</sup>
<b>Frequency range</b>	860 MHz ÷ 928 MHz
<b>Read range</b>	approx. 10m in air @ 2W ERP
<b>Memory capacity</b>	4k samples (8 Kbyte)
<b>Available Memory</b>	Up to 512 bits in EPC bank, up to 512 bits in User Memory bank
<b>Monitoring Delay Option</b>	Up to 18 hours
<b>Battery Type</b>	Li / MnO2 Model Renata CR 2450N
<b>Battery Life</b>	1 year (typical)
<b>Alarms</b>	Multiple user-configurable high temperature and low temperature alarms, ETA alarm, MKT alarm, shelf life alarm
<b>Shelf Life Prediction</b>	Calculations based on Arrhenius kinetic model with customer designation of time-temperature dependency
<b>Shelf Life Monitoring</b>	Provides Remaining Shelf Life information at check points with RFID reader or manual interface
<b>IP Rating</b>	IP67
<b>Dimensions (L,W,H)</b>	107 x 107 x 8.7 mm <sup>3</sup>
<b>Enclosure material</b>	PVC Tecnovil code: 21TV306TRS00000 <sup>(*)</sup>
<b>Weight</b>	31 g
<p><sup>(*)</sup>PVC Tecnovil 21TV306TRS00000 note:</p> <ul style="list-style-type: none"> <li>• this product is conforming to the “Decreto Ministeriale 21.03.73” (and further amended) and the European Directive 2002/72/CE (and further amended) concerning suitability of materials intended to come into contact with foodstuffs;</li> <li>• This product is conforming to the Regulation CE n. 1935/2004-, the reference element for the traceability is the batch number;</li> <li>• the producer has adopted a HCPP systems and operates in compliance with the Technical Specification BRC//IOP/2004 (product rating B);</li> <li>• this product is formulated with raw materials in conformity with FDA;</li> <li>• this product is conforming to the Directive 94/62/CE art. 9 20.12.94: the content of heavy metal (lead mercury cadmium, hexavalent chrome) is lower than 100 ppm.</li> </ul> <p>Please note that, according to the above mentioned legislation, the final packaging suitability as regards the content has to be tested by the user for migration and stability of the content in real condition of use. It is the responsibility of the final customer to verify the technological suitability of the product to its end use.</p>	

**Tab. 4.1: easy2log<sup>®</sup> RT0005 technical specification**



### Warnings:

- Do not incinerate, the product contains lithium battery.
- The activation electric field for the tag is 0.5 V/m in the range from 800 MHz up to 1 GHz. Prolonged exposure to electric fields greater than this value must be avoided in order to preserve the battery life.

<sup>1</sup> See § Air Link Protocol Characteristic page 29 for more information.

# Air Link Protocol Characteristic

## Physical Layer

The RT0005 tag in general satisfies the EPCglobal C1G2 physical layer protocol specification (see §[RD2]) with exception of the following points:

**Reader to tag data rates:** interrogator shall communicate using Tari value of 25 μsec only. Tari values of 12.5 μsec and 6.25 μsec are not supported.

**Tag to reader encoding:** the encoding format, selected in response to interrogator commands can be either FM0 or Miller (M=4) as specified in [RD2] chapter 6.3.1.3.2. Miller data encoding with M=2 and M=8 are currently not supported.

**Tag to reader data rates:** the RT0005 tag supports tag to interrogator data rates and link frequencies as specified in the following table:

DR Divide Ratio	TRcal <sup>2</sup>	LF Link Frequency	Encoding Type
8	200 μsec	40 kHz	FM0
64/3	66.6 μsec	320 kHz	Miller M=4
64/3	83.3 μsec	256 kHz	Miller M=4
64/3	85.3 μsec	250 kHz	Miller M=4

**Session:** Session S1 has an infinite persistence time, so have the S2 and S3 sessions.

**Commands:** all the EPC C1G2 mandatory commands are supported as well as the optional Access command.

<sup>2</sup> TRcal: Tag-to-Interrogator calibration symbol

## Mechanical Specification

Physical Dimension: millimeters

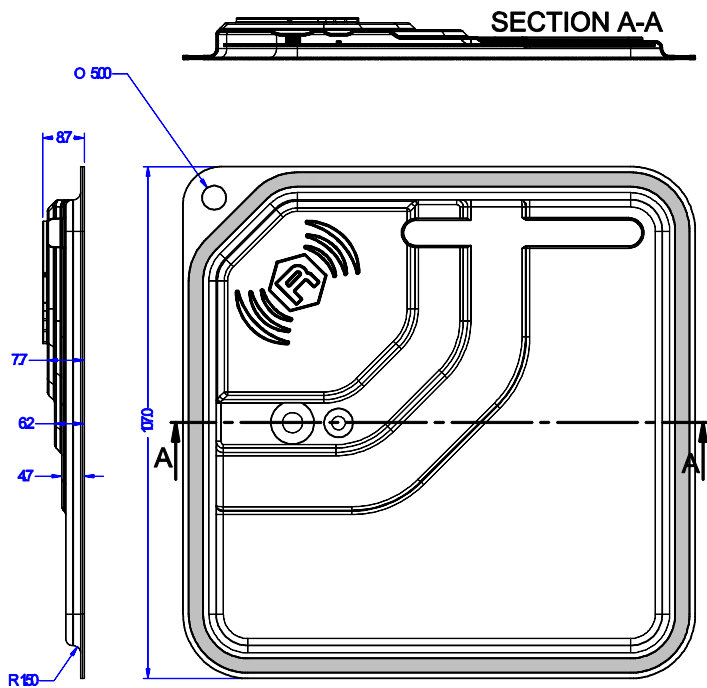
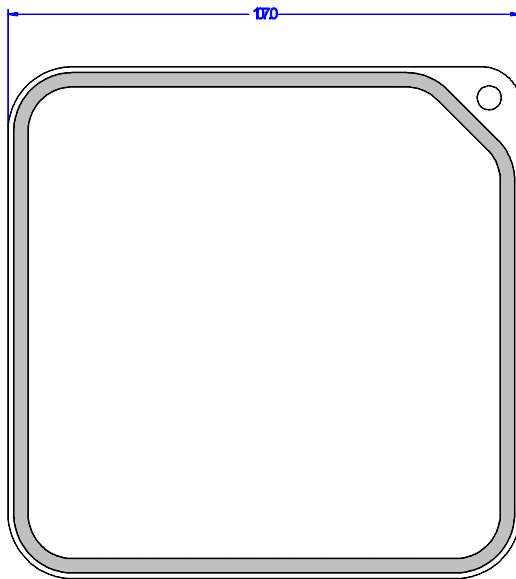

MATERIAL: PVC TECNOVIL 21TV306TRS00000 Thickness 0,4 mm

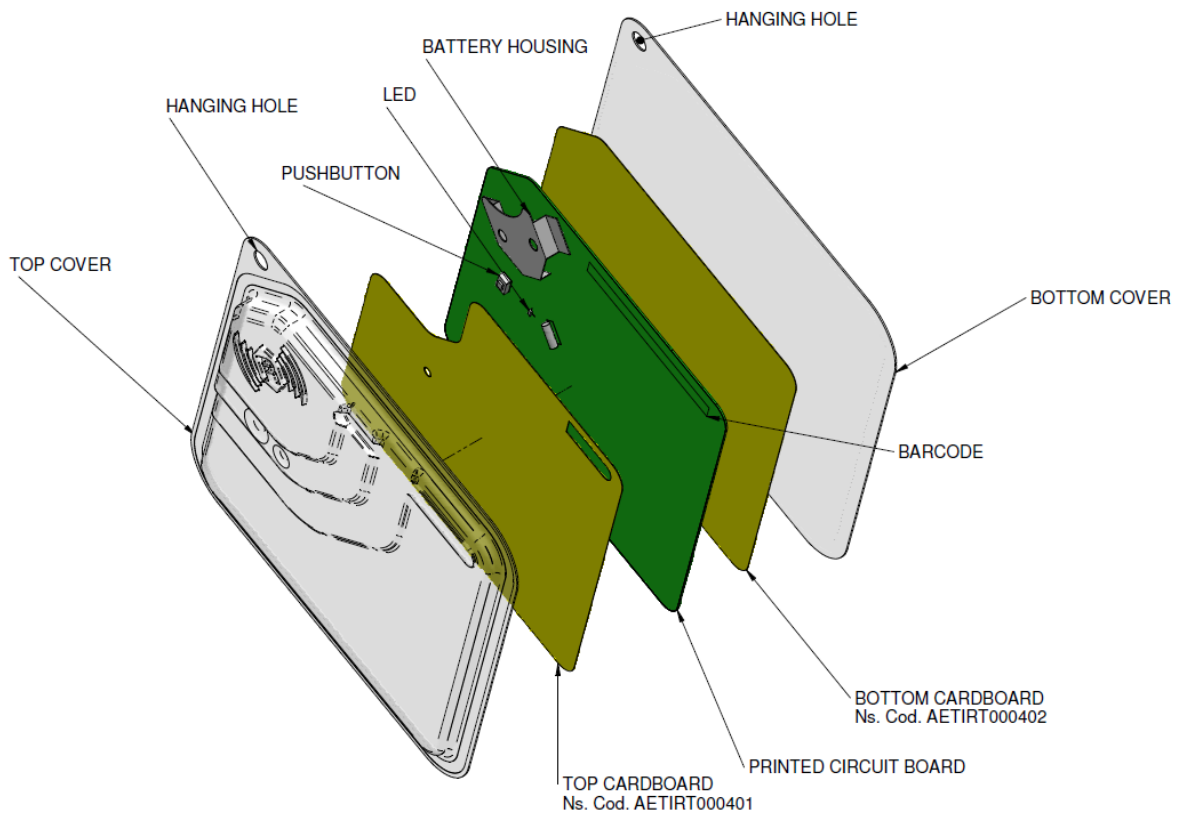

# 5 TEMPERATURE MEASUREMENT TRACEABILITY

## Temperature Accuracy Measurement

The easy2log<sup>®</sup> temperature loggers are individually tested before release, verifying operational functionality and product performance.

In addition, the easy2log<sup>®</sup> temperature loggers are individually calibrated for temperature accuracy measurement by CAEN RFID internal laboratory using the [CAEN RFID internal calibration procedure](#).

The temperature accuracy verification processes are in compliance with SIT/Tec-001/01<sup>3</sup> and are traceable to the International System of Units (SI) through the Italian Metrological Research National Institute (I.N.RI.M. Istituto Nazionale di Ricerca Metrologica)<sup>4</sup> and Italian Calibration Service (SIT Servizio di Taratura in Italia)<sup>5</sup>.

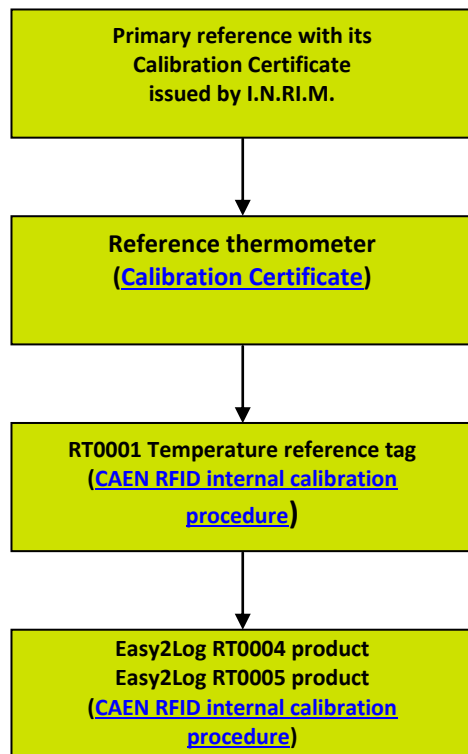

Fig. 5.1: Temperature measurement traceability chain

<sup>3</sup> SIT - Note per la stesura di una procedura di taratura di misuratori di temperatura e umidità con uscita digitale e trasmissione dati continua o differita ref. SIT/Tec-001/01- Revisione 0 – 17 Ottobre 2001

<sup>4</sup> <http://www.inrim.it/>

<sup>5</sup> <http://www.sit-italia.it/>

# 6 REGULATORY COMPLIANCE

## FCC Compliance

Not Required for UHF Semipassive Tag.

## CE Compliance

Reference standard:

ETSI EN 301 489-1 V. 1.9.2:2011

EN 55032:2012

CEI EN 55024:2013

ETSI EN 302 208 V3.1.1:2017

CEI EN 60950-1:2007 +/A11:2010 +/A1:2012 +/A12:2012

CEI EN 50364:2011

EN 50581:2012

See § *RT0005 CE Declaration of Conformity* page 33 for the RT0005 CE Compliance Certificate.

## Enclosure degree of protection

Reference standard:

CEI EN EN 60529

Reference document: TesLab 09B207A [RD1]

## RoHS EU Directive

easy2log<sup>®</sup> RT0005 UHF Semi-Passive Logger Tag is compliant with the EU Directive 2011/65/CE on the Restriction of the Use of certain Hazardous Substances in Electrical and Electronic Equipment (RoHS2).



# RT0005

## CE DECLARATION OF CONFORMITY

We

CAEN RFID Srl  
Via Vetraia, 11  
55049 Viareggio (LU)  
Italy  
Tel.: +39.0584.388.398 Fax: +39.0584.388.959  
Mail: info@caenrfid.com  
Web site: www.caenrfid.com

herewith declare under our own responsibility that the product:

**Code:** WRT0005XAAAA  
**Description:** RT0005 - Temperature logger UHF semi-passive tag(EPC C1G2) Blistered<sup>®</sup>

corresponds in the submitted version to the following standards:

ETSI EN 301 489-1 V. 1.9.2:2011  
EN 55032:2012  
CEI EN 55024:2013  
ETSI EN 302 208 V3.1.1:2017  
CEI EN 60950-1:2007 +/A11:2010 +/A1:2012 +/A12:2012  
CEI EN 50364:2011  
EN 50581:2012

and declare under our sole responsibility that the specified product meets the principle requirements and other applicable regulations of directives 2014/53/EU (RED) and 2011/65/EU (RoHS2)

Date: 25/07/2017

  
CAEN RFID Srl  
Via Vetraia, 11  
55049 VIAREGGIO ITALY  
VAT IT 02032050466

Adriano Bigongiari (Chief Executive Officer)

On the basis of this declaration, this product will bear the following mark:

